

PPC-1298PT-RMC

12" Rugged Panel PC, Intel 1.6GHz fanless CPU, 1G RAM, 160G HDD, VGA, Dual Gb LAN, 4 COM, PS2 KB-Mouse, Audio

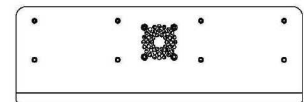
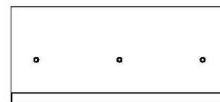
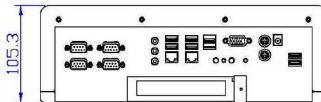
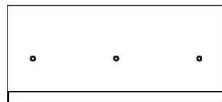
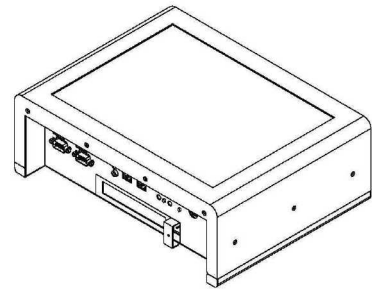
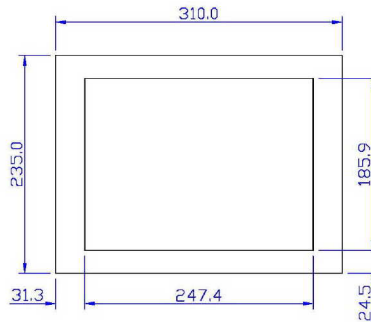
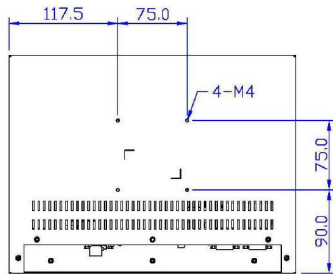
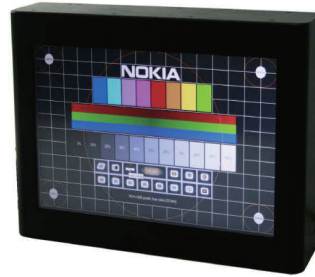

TECHNICAL SPECIFICATIONS

LCD Display Grade	
LCD Size	12" Active Matrix TFT LCD
Resolution	800 x 600 resolution
Aspect Ratio	4 : 3 standard ratio
Luminance	350 cd/m ²
Color Depth	16.7 million colors
View Angle	85(L) / 85(R) / 80(U) / 80(D) degree
Contrast Ratio	600 : 1 (typical)
Backlight life	50,000 Hours at 25°C ambient temperature

Touch Screen	
Touch Screen	12" long life 5-Wire Resistive Touch
Resolution	4096 x 4096 ultra high resolution

Mainboard	
CPU	Intel Ultra Low Voltage Atom 1.6GHz CPU
System Memory	1GB DDR2 RAM (Option : 2~4G SO-DIMM RAM)
Storage Device	80, 160, 320, 500G, 640GB anti-shock 2.5" HDD

Chipset	
System Chipset	Intel GSE945 and ICH7M

I/O Interface	
Graphics Chip	Intel GMA 950
Video RAM	224MB Video share RAM
COM (Serial)	4 RS232 COM Ports (Option : 6 COM Ports)
RS422 / 485	Option : 1 RS422 / 485
USB Port	6 USB2.0 Ports (Option : 8 USB Ports)
PS2 KB & Mouse	1 PS2 for Keyboard ; 1 PS2 for Mouse
Audio Port	Support Audio-In, Audio-Out, and Mic-in

Expansion Slot	
PCI Slot	1 PCI slot
Mini PCIe Slot	1 mini PCI-e slot for WiFi or else purpose
PCI-e x 1 Slot	1 PCI-e x1 slot
CF Slot	1 x Compact Flash slot
SATA Slot	2 x SATA free slots for second disk

Mechanical	
Front Bezel	Rugged steel chassis
Construction	Rugged steel construction
Color	Black color (Option : Silver)

Mounting Method	
Wall-Mount	Support VESA-75 wall mounting
Mounting Kit	Mounting Kit is available at extra cost

IP-65 Rate and I/O Connector	
Front Side	IP-65 Water-proof on front side
Back and Bottom	IP-54 on back and bottom sides

Environmental	
Operat Temperature	Meet MIL-STD-810F, 0°C to +60°C
Storage Temperature	Meet MIL-STD-810F, -20°C ~ +80°C
Shock	Meet MIL-STD-810F standard
Vibration	Meet MIL-STD-810F standard
CE	Meet CE standard
FCC	Meet FCC standard
RoHS	Meet RoHS standard

Power Adapter	
AC Power Source	External AC-DC adapter from 90 up to 264V
DC Power Source	Support DC 12V Power source
- DC24~28V	Optional DC18~32V power available at extra cost
UL Approval	UL Approval
cUL Approval	cUL Approval
TUV Approval	TUV Approval

Ordering Information	
PPC-8498T-RMC	8.4" Water-proof stainless steel touch Panel PC
PPC-1098T-RMC	10" Water-proof stainless steel touch Panel PC
PPC-1298T-RMC	12" Water-proof stainless steel touch Panel PC
PPC-1598T-RMC	15" Water-proof stainless steel touch Panel PC
PPC-1798T-RMC	17" Water-proof stainless steel touch Panel PC
PPC-1998T-RMC	19" Water-proof stainless steel touch Panel PC
PPC-2098T-RMC	20" Water-proof stainless steel touch Panel PC